

# MECHANICS HANDTOOLS

The Basics

NAME: \_\_\_\_\_

Print the name of the following tools neatly underneath their picture:

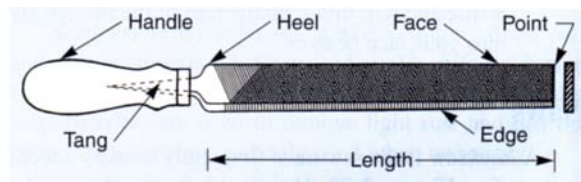
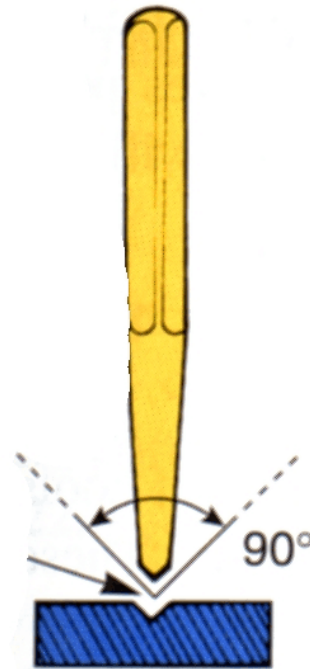

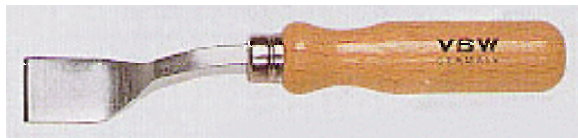
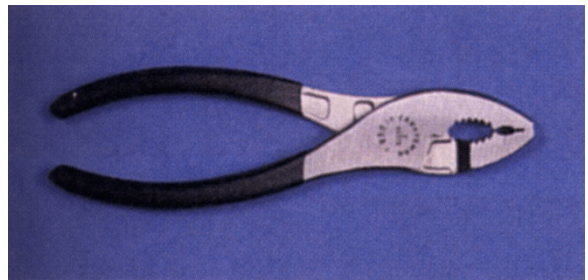
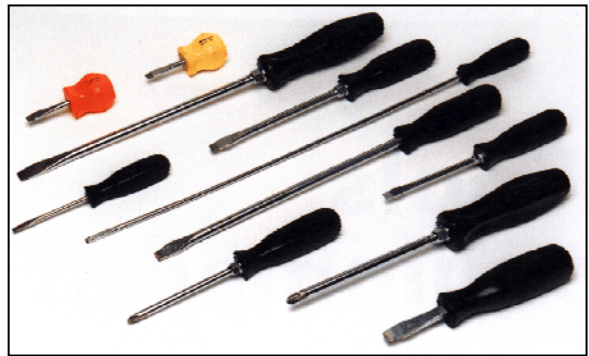
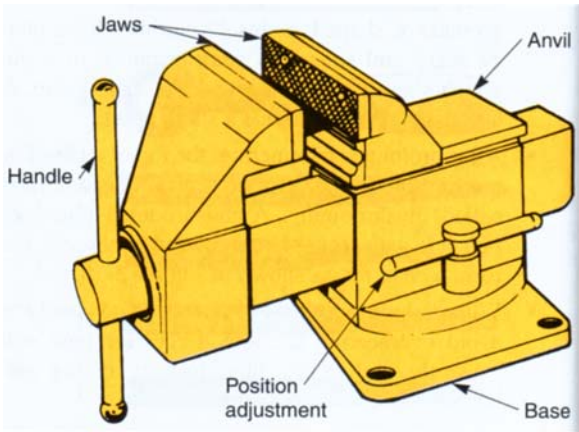

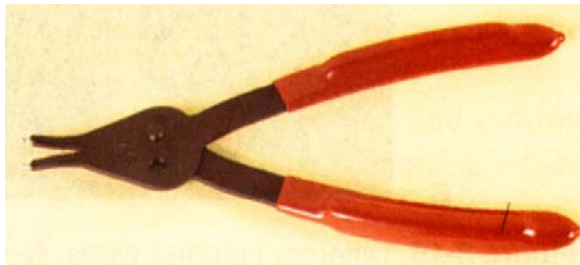
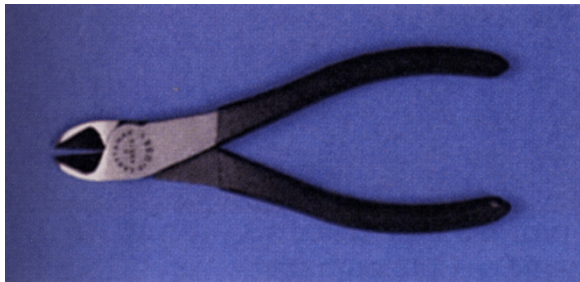
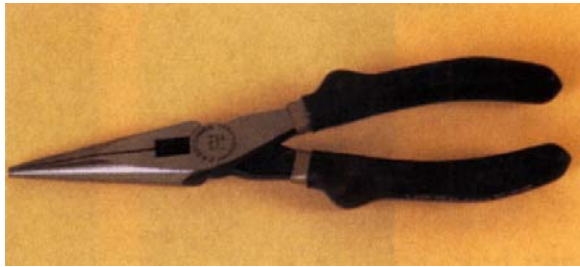

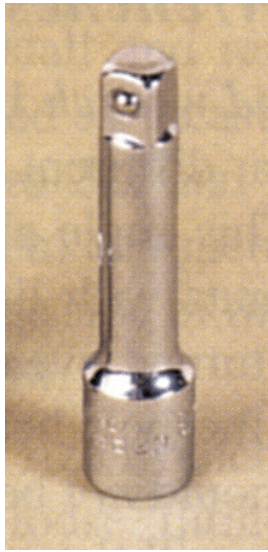

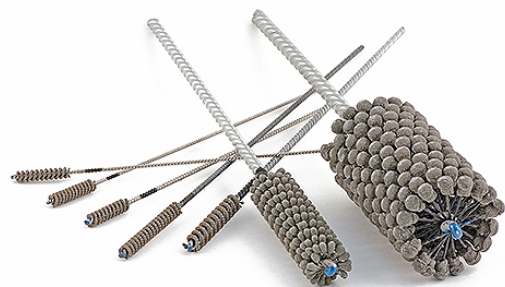





Sketch the tip of the following screwdrivers:

Philips (super common):

Robertson (never used as a factory fastener):

Torx (common):

Clutch (I've only ever seen in Holley carburetors):

When removing a fastener, given a choice, should you PUSH against the wrench, or PULL against the wrench? Explain why you chose your answer.